

TILBEHØRSOVERSIGT FOR PRÆCISIONS SKRUESTIKKE (GT-SERIEN)



S. 99

Spændejern



S. 99

Notsten



S. 99

Drejeskive

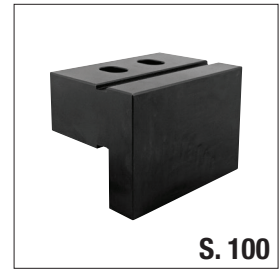

S. 100

Forhøjnings bakke

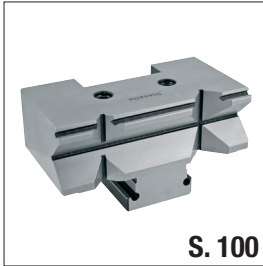

S. 100

Bevægelig prisme bakke

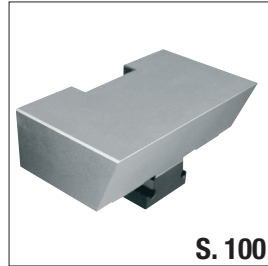

S. 100

Bevægelig bakke

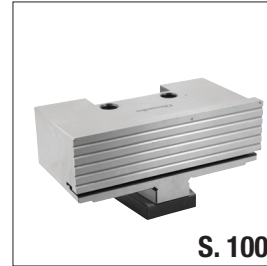

S. 100

Flydende bevægelig bakke

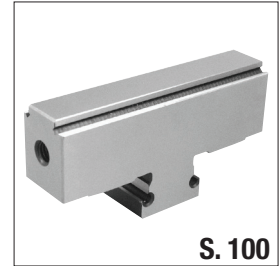

S. 100

Dobbelt center bakke

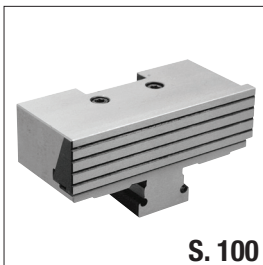

S. 100

Bevægelig bakke med kæbe



S. 98

Fast bakke med kæbe



S. 99

Arbejdsstop

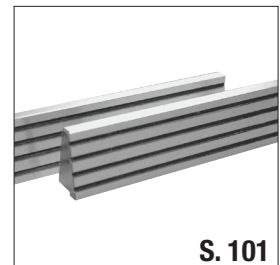

S. 101

Standard kæber



S. 101

Bløde kæber



S. 101

Glatte kæber

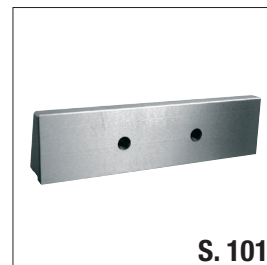

S. 101

Glatte kæber med M8 gevind

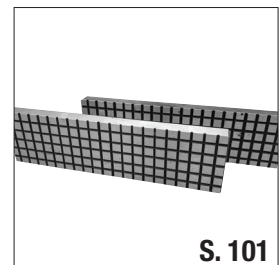

S. 101

Krydsrillet kæber



S. 101

Spindeldok



S. 101

Spindler



S. 101

Låseskruer

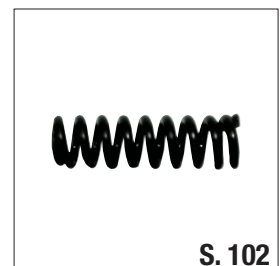

S. 102

Fjedre



S. 102

Spændenøgler

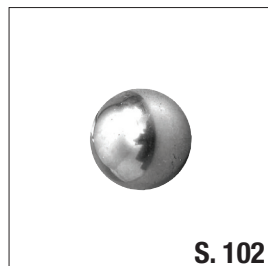

S. 102

Låsekugler

DOBBELT BASE XL

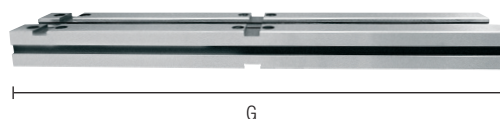

Vare nr.	Serie	Længde (G) mm	For kæbe bredde mm	Base bredde (-0,02) mm	Base højde (-0,02) mm	Vægt kg
40352460	1	460	100	75	35	7
40352520	2	520	125	95	40	12
40352580	3	580	150	125	50	22
40352666	4	666	175	145	58	32

SKRUESTIK XL

Bestående af:

- 1 stk. fast dobbelt bakke
- 2 stk. spindeldok med kæber

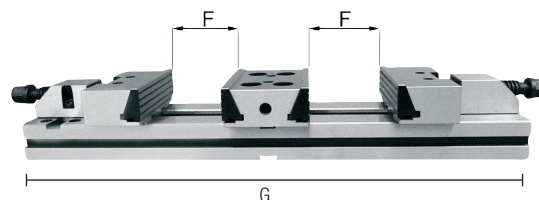

Vare nr.	Serie	Kæbe bredde mm	Spændevide (F) mm	Kæbe højde mm	Base bredde (-0,02) mm	Base højde (-0,02) mm	Længde (G) mm	Vægt kg
40351460	1	100	90	30	75	35	460	11,3
40351520	2	125	100	40	95	40	520	20,5
40351580	3	150	110	50	125	50	580	38,5
40351766	4	175	170	60	145	58	766	66
40351805	5	200	150	65	170	70	805	98

SKRUESTIK XL

Bestående af:

- 1 stk. fast dobbelt bakke med kæber
- 1 stk. spindeldok med kæbe.

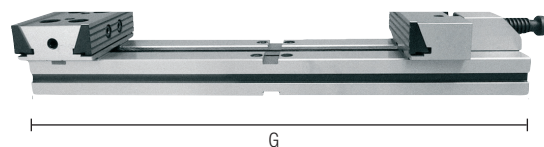

Vare nr.	Serie	Kæbe bredde mm	Spændevide (E) mm	Kæbe højde mm	Base bredde (-0,02) mm	Base højde (-0,02) mm	Længde (G) mm	Vægt kg
40350460	1	100	290	30	75	35	460	10
40350520	2	125	320	40	95	40	520	17
40350580	3	150	360	50	125	50	580	33
40350666	4	175	400	60	145	58	666	53

BASE MED BEVÆGELIG BAKKE

Inkl. tilbehør:

Spændejern, notsten 16x18 mm, spændenøgle og unbrakonøgle.

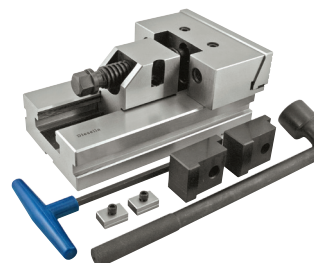
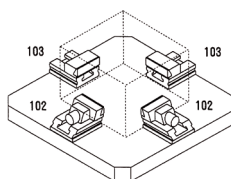
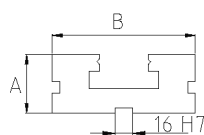

Vare nr.	Serie	Længde base	Kæbe bredde mm	Kæbe højde mm	Base bredde (B) mm	Base højde (-0,02) (A) mm	Vægt kg
40355140	1	140	100	30	75	35	4
40355160	2	160	125	40	95	40	7
40355230	3	230	150	50	125	50	15
40355240	4	240	175	60	145	58	22
40355300	5	300	200	65	170	70	35

BASE MED FAST BAKKE

Inkl. tilbehør: Spændejern, notsten 16 x 18 mm og arbejdsstop.

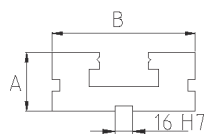

Vare nr.	Serie	Længde base mm	Kæbe bredde mm	Kæbe højde mm	Base bredde (B) mm	Base højde (-0,02) (A) mm	Vægt kg
40356140	1	140	100	30	75	35	4
40356160	2	160	125	40	95	40	6
40356230	3	230	150	50	125	50	13
40356240	4	240	175	60	145	58	18
40356300	5	300	200	65	170	70	30

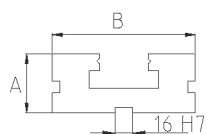
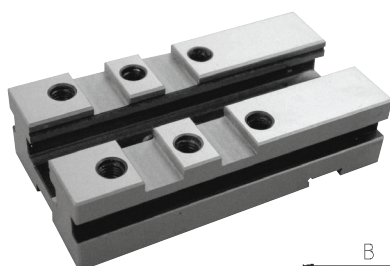

BASE ENHED

Til fast bakke.

Vare nr.	Serie	Længde base mm	(B) Base bredde mm	Base højde (-0,02) (A) mm	Vægt kg
40353140	1	140	75	35	3
40353160	2	160	95	40	5
40353230	3	230	125	50	12
40353240	4	240	145	58	16
40353300	5	300	170	70	27

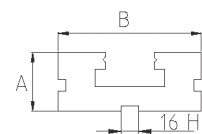

BASE ENHED

Til bevægelig bakke eller understøtning af lange emner.

Vare nr.	Serie	Længde base mm	(B) Base bredde mm	Base højde (-0,02) (A) mm	Vægt kg
40354140	1	140	75	35	3
40354160	2	160	95	40	5
40354230	3	230	125	50	12
40354240	4	240	145	58	16
40354300	5	300	170	70	27

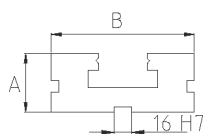

DOBBELT FAST BAKKE MED KÆBER

Leveres inkl. 2 stk. kæber.

Vare nr.	Serie	Mål b x h x t
40358100	1	100 x 30 x 84,78 mm
40358125	2	125 x 40 x 84,78 mm
40358150	3	150 x 50 x 101,78 mm
40358175	4	175 x 60 x 110,78 mm



FAST BAKKE MED KÆBE

Standard.

Vare nr.	Serie	Til skruestik nr.	Indhold
40357125	2	40335150	1 stk
40357150	3	40335175 > 40335200	1 stk
40357175	4	40335225 > 40335300	1 stk
40357200	5	40335325 > 40335425	1 stk

SPÆNDEJERN

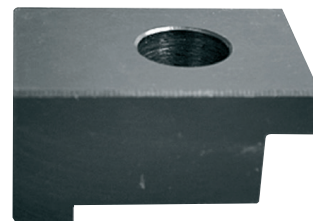
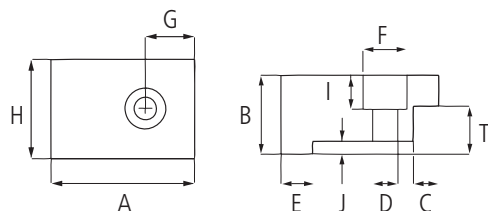

Vare nr.	Serie	A mm	B mm	C mm	D mm	E mm	F mm	G mm	H mm	I mm	J mm	T mm	Til skruestik ART.	Indhold stk.
40380100	1	50	25	8	8	10	14	17	34	11	4	15	40335125	4
40380125	2	50	25	8	10	10	17	21	34	11	4	15	40335150	4
40380150	3+4	60	30	8	12	13	19	23	42	12	4	20	40335175 > 40335300	4
40380155 (XL)	3+4	70	30	8	18	13	27	33	42	18	4	20	40335175 > 40335300	4
40380200	5	60	40	10	12	15	17	27	50	10	4	26	40335325 > 40335425	4
40380205 (XL)	5	75	40	10	20	15	31	42	50	20	4	26	40335325 > 40335425	4

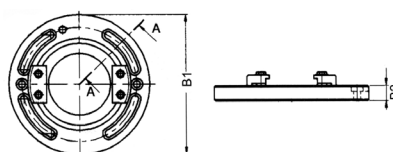
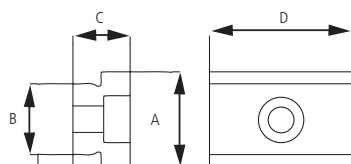

NOTSTEN

Anvendes til orientering af skruestikke på planet. Tolerance: h6 / h7.
Diesella præcisions skruestikke af typen GT har 16 mm notspor (B)

Vare nr.	A	B	C	D	Indhold	For M
40385510	12 mm	16 mm	10 mm	25 mm	2 stk	M5 x 10 mm
40385525	14 mm	16 mm	10 mm	25 mm	2 stk	M5 x 10 mm
40385570	16 mm	16 mm	10 mm	25 mm	2 stk	M5 x 10 mm
40385600	18 mm	16 mm	10 mm	25 mm	2 stk	M5 x 10 mm
40385645	20 mm	16 mm	10 mm	25 mm	2 stk	M5 x 10 mm
40385680	22 mm	16 mm	10 mm	25 mm	2 stk	M5 x 10 mm
40385725	24 mm	16 mm	10 mm	25 mm	2 stk	M5 x 10 mm
40385540	14 mm	18 mm	10 mm	25 mm	2 stk	M5 x 10 mm
40385555	14 mm	20 mm	10 mm	25 mm	2 stk	M5 x 10 mm
40385585	16 mm	18 mm	10 mm	25 mm	2 stk	M5 x 10 mm
40385615	18 mm	18 mm	10 mm	25 mm	2 stk	M5 x 10 mm
40385630	18 mm	20 mm	10 mm	25 mm	2 stk	M5 x 10 mm
40385660	20 mm	18 mm	10 mm	25 mm	2 stk	M5 x 10 mm
40385675	20 mm	20 mm	10 mm	25 mm	2 stk	M5 x 10 mm
40385695	22 mm	18 mm	10 mm	25 mm	2 stk	M5 x 10 mm
40385710	22 mm	20 mm	10 mm	25 mm	2 stk	M5 x 10 mm

Nedstående er til ART. 40404xxx / 40405xxx skruestikke, som har 18 mm spor (B)

Vare nr.	A	B	C	D	Indhold	For M
40385850	14 mm	18 mm	12 mm	25 mm	2 stk	M6 x 10 mm
40385860	16 mm	18 mm	12 mm	25 mm	2 stk	M6 x 10 mm
40385870	18 mm	18 mm	12 mm	25 mm	2 stk	M6 x 10 mm
40385880	20 mm	18 mm	12 mm	25 mm	2 stk	M6 x 10 mm
40385890	22 mm	18 mm	12 mm	25 mm	2 stk	M6 x 10 mm

DREJESKIVE FOR GT-SERIEN

Vare nr.	Serie	B1	B2	Til skruestik ART.
40394100	1	180 mm	18 mm	40335125
40394125	2	225 mm	23 mm	40335150
40394150	3	290 mm	28 mm	40335175 > 40335200
40394175	4	320 mm	28 mm	40335225 > 40335300
40394200	5	370 mm	34 mm	40335325 > 40335425

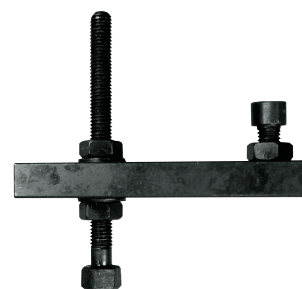

ARBEJDSSTOP

Til fixering af emner.

Vare nr.	Serie	Til skruestik ART.	Indhold
40390100	1	40335125	1 stk
40390125	2	40335150	1 stk
40390150	3 + 4	40335175 > 40335300	1 stk
40390200	5	40335325 > 40335425	1 stk

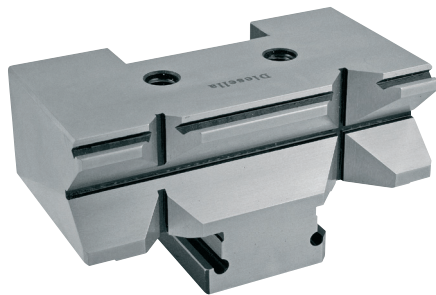

PRISME BAKKE BEVÆGELIG

Præcisionslebet, spændespor på overkant til fixering af tynde emner.

1 stk. horisontal V-spor til runde emner.

2 stk. vertikal V-spor til runde emner.

Vare nr.	Serie	Til skruestik nr.	Mål mm	Ø max horisontal / vertikal mm	Indhold
40374125	2	40335150	121 x 38	Ø 15-12/15	1 stk
40374150	3	40335175 > 40335200	146 x 48	Ø 25-15/25	1 stk
40374175	4	40335225 > 40335300	171 x 58	Ø 38-25/38	1 stk
40374200	5	40335325 > 40335425	195 x 62	Ø 40-38/40	1 stk

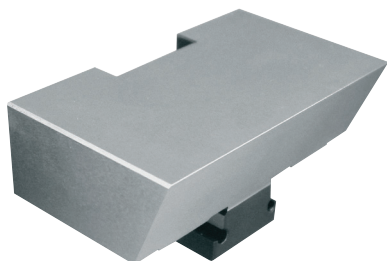

BEVÆGELIG BAKKE

Spec. for runde emner.

Vare nr.	Serie	Til skruestik nr.	Mål mm	Ø max horisontal / vertikal mm	Indhold
40372125	2	40335150	121 x 38	50	1 stk
40372150	3	40335175 > 40335200	146 x 48	65	1 stk
40372175	4	40335225 > 40335300	171 x 58	80 mm	1 stk

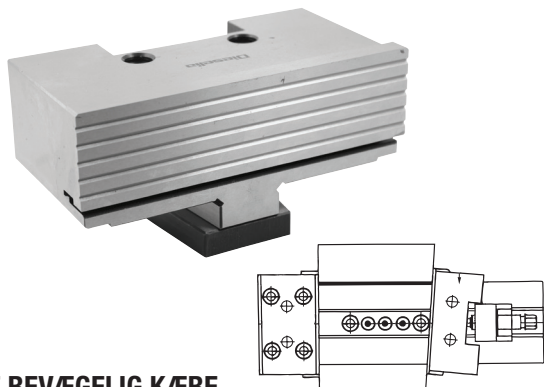

FLYDENDE BEVÆGELIG KÆBE

Til fastspænding af skæve emner.

Vare nr.	Serie	Til skruestik ART.	Kæbe bredde	Kæbe højde	Indhold
40370150	3	40335175 > 40335200	150 mm	50 mm	1 stk
40370175	4	40335225 > 40335300	175 mm	60 mm	1 stk
40370200	5	40335325 > 40335425	200 mm	65 mm	1 stk

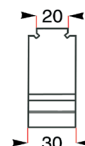
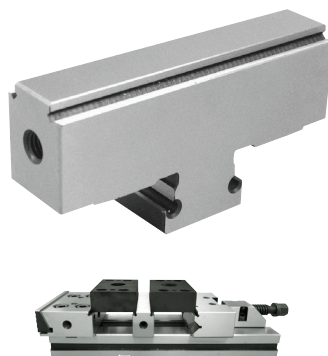

DOBBELT CENTER BAKKE (FLYDENDE)

Præcisionslebet, spændespor på overkant til fixering af tynde emner, bruges evt. sammen med ART. 40374xxx.

* ART. 40373155 er fuldkantet.

Vare nr.	Serie	Til skruestik ART.	Kæbe bredde	Kæbe højde	Indhold
40373125	2	40335150	121 mm	40 mm	1 stk
40373150	3	40335175 > 40335200	146 mm	50 mm	1 stk
40373155*	3	40335225 > 40335300	146 mm	60 mm	1 stk
40373175	4	40335225 > 40335300	171 mm	60 mm	1 stk
40373200	5	40335325 > 40335425	196 mm	65 mm	1 stk

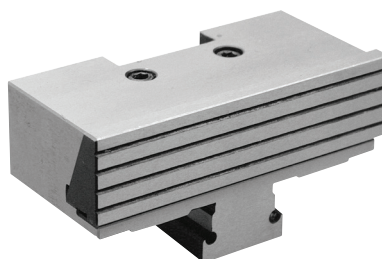

BEVÆGELIG BAKKE MED KÆBE

Standard.

Vare nr.	Serie	Til skruestik nr.	Indhold
40386100	1	40335125	1 stk
40386125	2	40335150	1 stk
40386150	3	40335175 > 40335200	1 stk
40386175	4	40335225 > 40335300	1 stk
40386200	5	40335325 > 40335425	1 stk

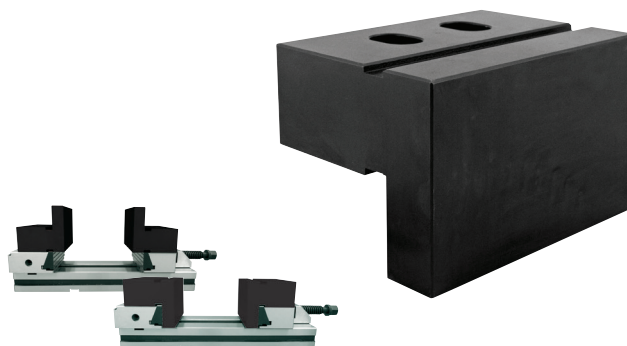

FORHØJNINGS BAKKE

Hæver arbejdshøjden, uhærdet/hærdbar.

Vare nr.	Serie	Til skruestik ART.	Mål	Indhold
40371125	2	40335150	121 x 78 x 20 mm	2 stk
40371150	3	40335175 > 40335200	146 x 98 x 30 mm	2 stk
40371175	4	40335225 > 40335300	171 x 118 x 30 mm	2 stk
40371200	5	40335325 > 40335425	196 x 128 x 30 mm	2 stk

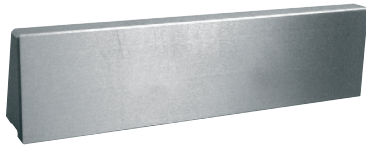

GLATTE BAKKER

Hærdet, glat overflade, sæt á 2 stk.

Vare nr.	Serie	Til skruestik ART.
40377125	2	40335150
40377150	3	40335175 > 40335200
40377175	4	40335225 > 40335300
40377200	5	40335325 > 40335425

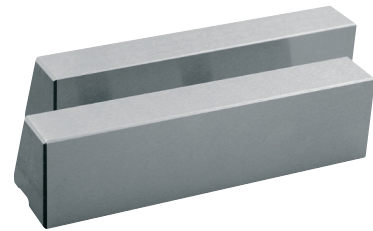

BLØDE BAKKER I SÆT

Uhærdet, kan bearbejdes og herefter hærdes. Sæt á 2 stk.

Vare nr.	Serie	Til skruestik ART.	Mål
40376100	1	40335125	100 x 22 mm
40376125	2	40335150	125 x 22 mm
40376150	3	40335175 > 40335200	150 x 22 mm
40376175	4	40335225 > 40335300	175 x 22 mm
40376200	5	40335325 > 40335425	200 x 22 mm

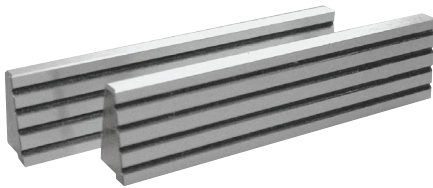

LØSE BAKKER

Hærdet, riflet overflade, sæt á 2 stk.

Vare nr.	Serie	Til skruestik ART.
40379115	1	40335125
40379125	2	40335150
40379150	3	40335175 > 40335200
40379175	4	40335225 > 40335300
40379200	5	40335325 > 40335425

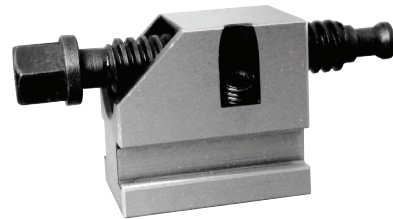

SPINDELDOK (KOMPLET)

* Udført med 2 spændeskruer (én i hver side).

Vare nr.	Serie	Til skruestik ART.	Spændeskruer
40378100	1	40335125	1 stk
40378125	2	40335150	1 stk
40378150	3	40335175 > 40335200	1 stk
40378155*	3	40335175 > 40335200	2 stk
40378175	4	40335225 > 40335300	1 stk
40378180*	4	40335225 > 40335300	2 stk
40378200	5	40335325 > 40335425	1 stk

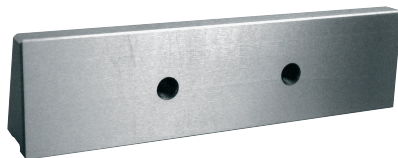

GLATTE BAKKER M. M8 GEVINDHJUL

Speciel til egen fixtur. Sæt á 2 stk.

Vare nr.	Serie	Serie	Til skruestik ART.
40379800	1	M6	40335125
40379825	2	M8	40335150
40379850	3	M8	40335175 > 40335200
40379875	4	M8	40335225 > 40335300



SPINDEL

Udført i trapez gevind eller MM gevind.

Vare nr.	Serie	Gevind	Til skruestik ART.
40387305	1	M12	40335125
40387315	1	M14	40335125
40387325	1	TR14x4	40335125
40387345	2	TR18x4	40335150
40387375	3+4	TR24x5	40335175 > 40335300
40387405	5	TR36x6	40335325 > 40335425

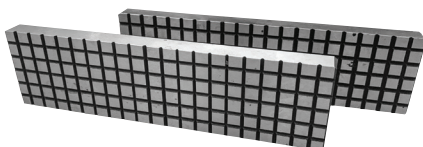

KRYDSRILLEDE KÆBER

Vare nr.	Serie	Til skruestik ART.
40379550	3	40335175 > 40335200



LÅSEKRUE

Spænder på låsekuglen.

Vare nr.	Serie	Til skruestik ART.	Indhold
40393100	1	40335125	1 stk
40393125	2	40335150	1 stk
40393150	3	40335175 > 40335200	1 stk
40393175	4	40335225 > 40335300	1 stk
40393200	5	40335325 > 40335425	1 stk



ART. 40389xxx

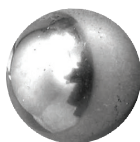

ART. 40388xxx

FJEDER OG KUGLE

Vare nr.	Serie	Til skruestik ART.	Indhold
Fjeder			
40389100	1+2	40335125 > 40335150	2 stk
40389150	3+4	40335175 > 40335300	2 stk
40389200	5	40335325 > 40335425	2 stk
Kugle			
40388100	1	40335125	1 stk
40388125	2	40335150	1 stk
40388150	3+4	40335175 > 40335300	1 stk
40388200	5	40335325 > 40335425	1 stk

**SPÆNDENØGLE**

Med sekskant-hoved, chrom vanadium.

Vare nr.	Serie	Til skruestik ART.	NV	Indhold
40391100	1	40335125	12	1 stk
40391125	2	40335150	19	1 stk
40391150	3+4	40335175 > 40335300	22	1 stk
40391200	5	40335325 > 40335425	30	1 stk
40391215	5	-	36	1 stk